

FARMMI®

FOREST

Made in Finland

FARMMI MASTERSPLIT: WP30, WP36 and WP36HC

THE FARMMI FIREWOOD PROCESSORS FOR PRODUCING TOP-QUALITY FIREWOOD WITH GREATER SAFETY, EFFICIENCY AND EASE

Cross cutting is done lightly and quietly by a chainsaw function. Chainsaw is running only during cutting. Automatic lubrication of chain by pump. Splitting is done hydraulically into 2 or 4 parts. Splitting speed is increased by over 40% when using the rapid action function. Extra equipment includes blade splitting into to 6 pieces. **WP 36 HC** is equipped with a hydraulic chainsaw and a hydraulically adjustable splitting knife.

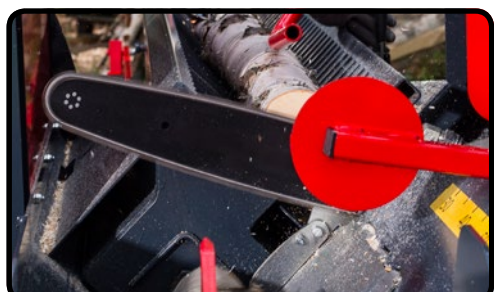
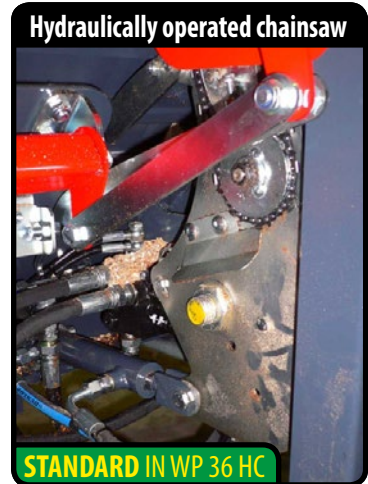

FARMI MASTERSPLIT WP 30/36 with a trailer



ACCESSORY

Adjustable conveyor

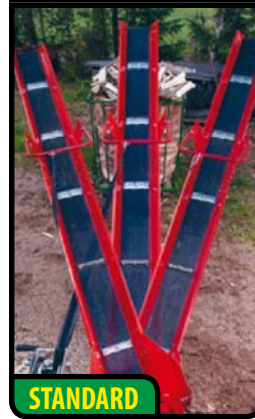

STANDARD

Log lifter

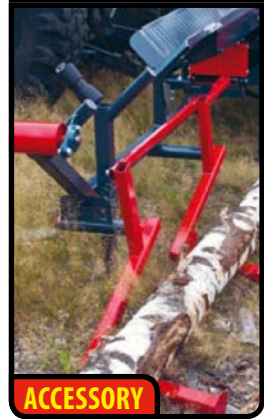

ACCESSORY

6-piece splitting knife



ACCESSORY

Log table



ACCESSORY

Adjustable height 25 cm

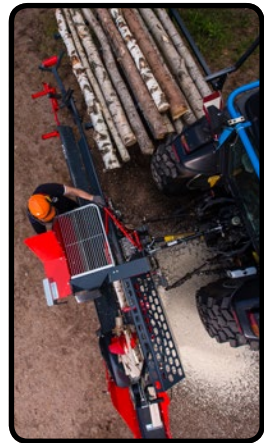
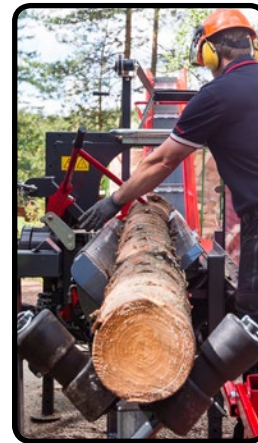
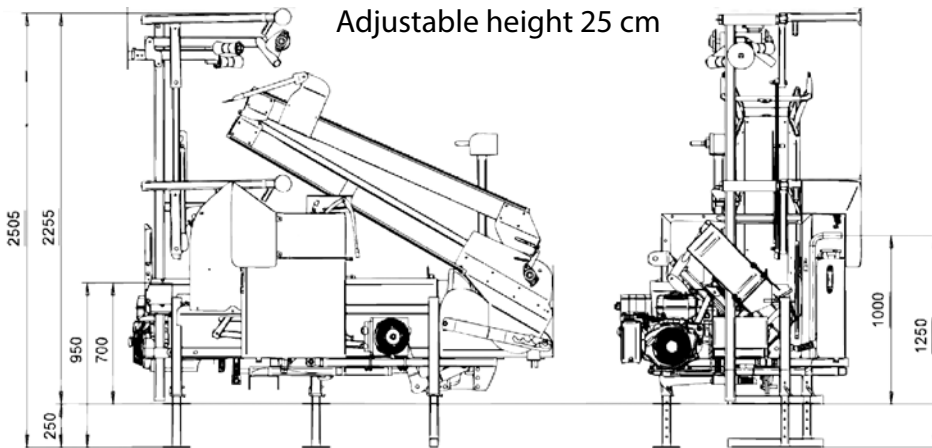

TECHNICAL INFORMATION

	WP 30	WP 36	WP 36 HC
CROSS CUTTING BY CHAINSAW	13"	15"	15"
DRIVE OF CHAINSAW	Hydraulic	Hydraulic	Hydraulic
SPLITTING FORCE, max. tons	5,6	8	8
CROSS CUTTING SPEED normal / rapid movement	ø 30 cm 2,4 / 1,6 s	ø 36 cm 1,5 / 1,0 s	ø 36 cm 1,5 / 1,0 s
STEM DIAMETER / LENGTH OF SPLIT WOOD	30 cm / 60 cm	36 cm / 60 cm	36 cm / 60 cm
CONVEYOR BELT WIDTH	24 cm	24 cm	24 cm
CONVEYOR LENGTH	4.0 m	4.0 m	4.0 m
DRIVE OF CONVEYOR	Hydraulic	Hydraulic	Hydraulic
WEIGHT	500 kg	520 kg	520 kg
POWER REQUIREMENT	7.5 kW	7.5 kW	7.5 kW
POWER SOURCE	Tractor / Electric motor / Gasoline motor		
TRANSPORTATION WIDTH / HEIGHT, mm	2340 / 2250	2340 / 2250	2340 / 2250
TRANSPORT PLATFORM (trailer)	Accessory	Accessory	Accessory
ADJUSTMENT OF THE SPLITTING DEVICE	Manual	Manual	Hydraulic
CHAINSAW	Manual	Manual	Hydraulic

Manufacturer reserves right to make changes in specifications.

FARMI[®] Forest

Farmi Forest Corporation
Ahmolantie 6
FI-74510 Iisalmi
FINLAND
Tel. +358 17 832 41
info@farmiforest.fi
www.farmiforest.fi

